

毛刷型括刷片

毛高(H=10, 15, 20, 25, 30, 40, 45, 50)

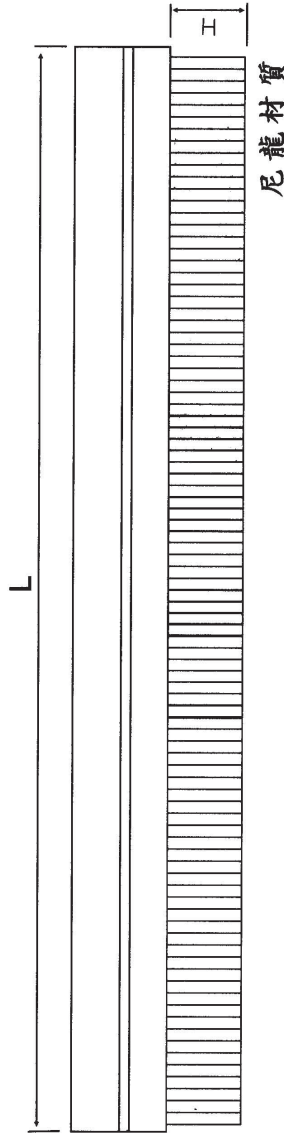

尼龍材質

1. 訂購時請填註高度 H , 長度 L .
2. 如有特殊尺寸時, 請附圖面訂製.

機械配件

毛刷型刮刷片

毛高(H:50~100)

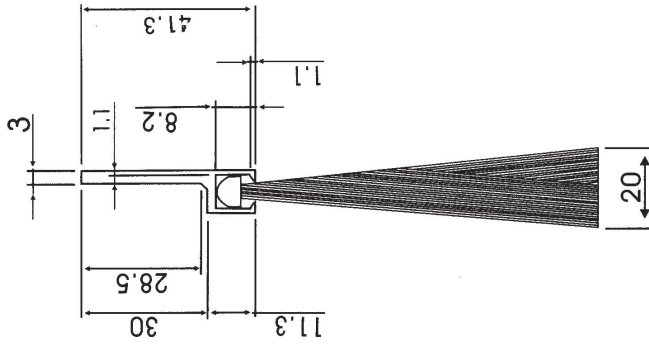
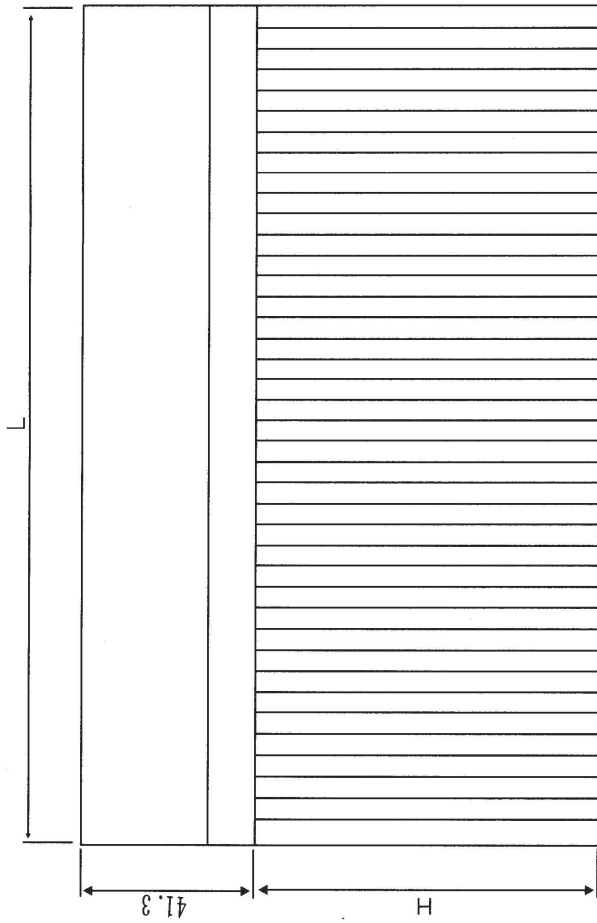

尼龍材質

1. 訂購時請填註高度 H, 長度 L.
2. 如有特殊尺寸時, 請附圖面訂製.

機械配件

刮刷片

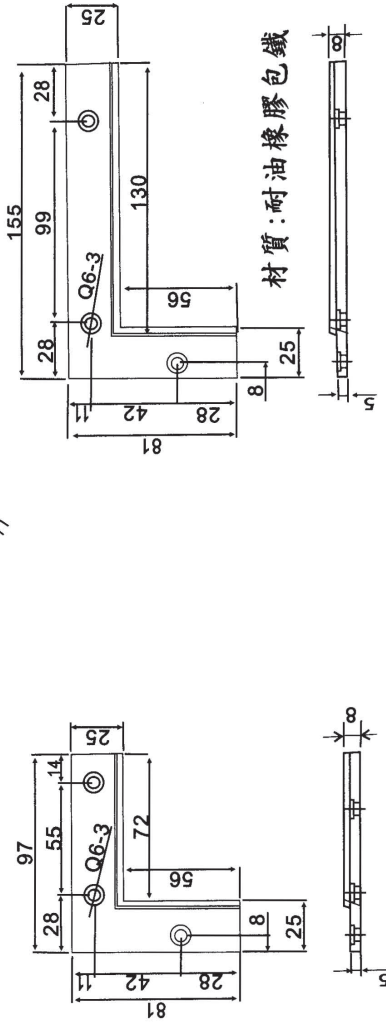
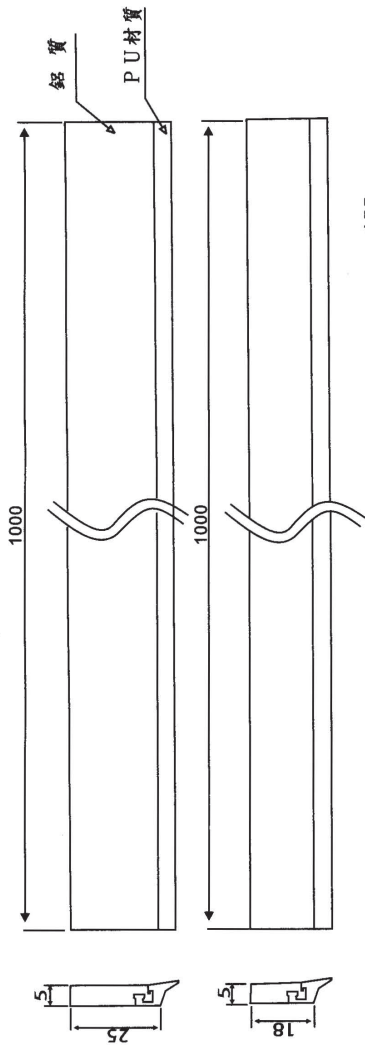

單位: ㎜/㎜

機械配件

PU刮刷片：(長度皆為1000mm)

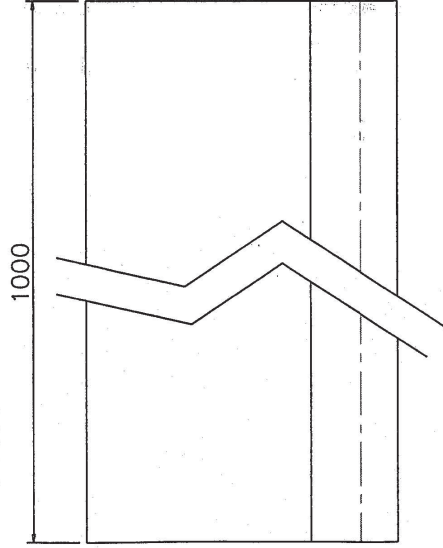

25mm型

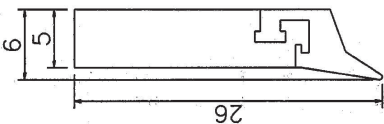

20mm型

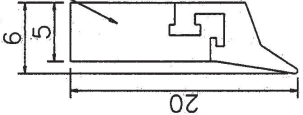

18mm型

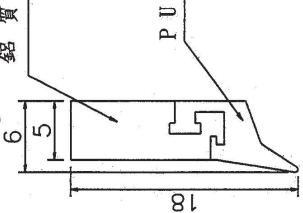

PU材質(耐油、耐熱、耐磨)

50mm型

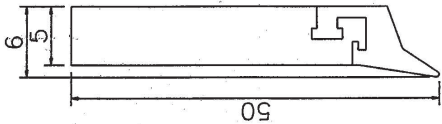

35mm型

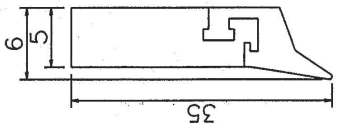

30mm型

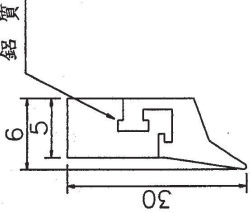

鋁質

鋁質

鋁質

鋁質

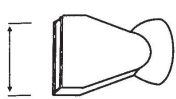
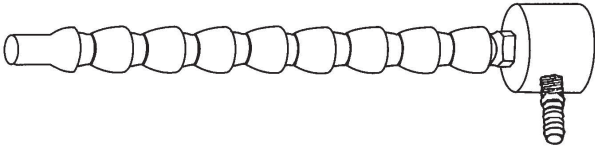
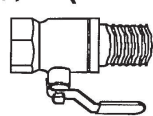
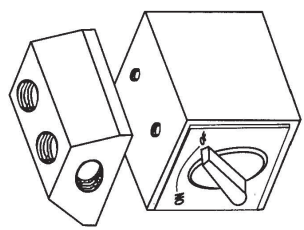
		 <p>球型凡而 1/4, 3/8, 1/2</p>	<p>噴嘴</p>	<p>管身</p>	<p>接頭</p>
<p>扁嘴 10.25m / m 孔徑 $\phi 3, \phi 6$</p>	<p>1/4</p>	<p>1/4</p>	<p>扁嘴 32.64m / m 孔徑 $\phi 6, \phi 9$</p>	<p>3/8</p>	<p>3/8</p>
<p>扁嘴 32.64m / m 孔徑 $\phi 6, \phi 9$ $\phi 12$</p>	<p>1/2</p>	<p>1/2</p>	<p>單孔噴油磁座</p>	 <p>雙孔噴油磁座</p>	